

A light, compact and  
adaptable laser  
marking solution

Laser Marking Systems

## 7230 & 7330 Fiber Lasers





# The freedom to mark how *you* want

With over 30 years of laser marking expertise, Videojet brings deep understanding of interaction between the laser source and the substrate to ensure your fiber laser mark looks exactly how you want it to look.

# Videojet is uniquely positioned to allow you the freedom to mark how you want with the latest Videojet 7230 (10-Watt) and 7330 (20-Watt) fiber laser marking systems.

## Uptime Advantage

- Maximize performance with long-life laser source expectancy up to 100,000 hours mean time before failure (MTBF)
- Air-cooled laser source that virtually eliminates maintenance intervals
- No wear parts help to minimize downtime

## Simple Usability

- Focus more on production and less on user interaction and maintenance with an easy-to-use laser solution that is intuitive to the operator without the need for additional training
- Reduce the risk of rework and recalls with familiar look and feel user interfaces, offering simple operation and message creation
- Choose from a variety of user interfaces to control Videojet laser marking systems, including Videojet Touch Control Software (TCS+) and Videojet CLARiTY™ utilized in other Videojet marking and coding solutions

## Built-in Productivity

- Improve marking productivity with a combination of the largest marking window in the industry and 2000 characters per second marking speeds\*
- Benefit from standard and customizable communication protocols
- Achieve top speeds with serialization data and complex codes, thanks to faster data processing capabilities versus previous Videojet lasers

## Easy Integration

- Benefit from greater versatility in tight spaces with a compact, lightweight marking head weighing only 4.4kg\*
- Seamlessly integrate the 7230 or 7330 fiber laser into your production line with EtherNet / IP™ and PROFINET\*\*
- Achieve greater flexibility in production line integration with a choice of working distances, and the orientation option of either a straight or 90 degree marking head



\* With 6mm laser marking head

\*\* Ethernet/IP is a trademark of ODVA.

PROFINET is a registered trademark of Profibus & Profinet International (PI).

# 7230 & 7330 Fiber Lasers

## Powerful marking solutions for total operational freedom

Developed to meet the needs of manufacturers who work with robust, high-density materials, the Videojet 7230 (10-Watt) and 7330 (20-Watt) are versatile fiber lasers that offer high-speed marking, with complex data, easy operability and industry-leading integration capabilities.

The 7230 and 7330 fiber lasers are an ideal solution for demanding production schedules in the Parts-Marking, Food, Beverage, Consumer Packaged Goods (CPG) and Pharmaceutical industries that need a laser marking system to keep pace and provide a high-level of code contrast, exceeding your productivity expectations.



---

### Seamless operation

Choose from a variety of user interfaces to control your Videojet 7230 and 7330 fiber laser marking system, ensuring seamless operation with familiar look and feel user interfaces. Videojet TCS+ is designed to offer you flexible integration, simple operation and remote laser control through either the Videojet TU440 10.1" color touchscreen interface, or from virtually any browser-based device. The advanced Videojet CLARiTY™ laser controller is an alternative optional user interface, featuring an intuitive touchscreen also used in other Videojet marking and coding solutions, that allows for simple operation and continuous improvement in uptime and productivity.

---

### Increased productivity

Benefit from a versatile laser solution that is available with the option of a 6mm and 10mm marking head, covering a wide variety of marking and coding operations. In addition to this, the 7230 and 7330 fiber laser marking systems also offer you enhanced productivity benefits by allowing you to mark more products and codes, faster than previous Videojet lasers, due to a combination of improved data processing speeds and competitive marking speeds of up to 2,000 characters per second (speed based on 6mm marking head).

---

### Simple integration

Achieve easy integration and greater versatility in tight spaces with a combined laser head and controller weight of less than 25kg – 44% lighter than other fiber laser providers. You can also benefit from the smallest laser head dimensions for simple integration into complex machinery.

**Laser marking head**

Weighing only 4.4kg, the 6mm laser head offers a smaller, lighter footprint, versus other fiber laser providers, for greater versatility in tight spaces

**Option of 0° or 90° degree marking head orientation**

Provides flexibility on production lines with space limitations

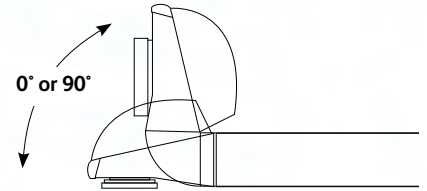

**Small laser head dimensions**

For easy integration into existing production lines

**Select between 2 marking heads**

6mm or 10mm provide up to 8 marking fields, offering flexibility & application confidence for varying product shapes and sizes

**Ultra-precise beam control**

Provides high-quality, high-density codes at high speeds on multiple high density substrates without damaging product aesthetic

**Easy-to-use**

Familiar color user interface for simple code entry, helping to reduce the risk of rework and recalls



**EtherNet/IP**  
**PROFI**<sup>®</sup>  
**NET**

Optional industrial protocols for control, communication and data collection

**Fast**

Marking speeds up to 2,000 characters per second (with 6mm laser head) allows laser to mark more complex data and increased code content

**Safe**

Permanent, high contrast laser codes increase product security and safety

**Laser beam delivery**

Offers same high-quality marking onto a product within the usable depth of field, substrate dependent

**Easy Integration**

Largest marking field in the industry with the smallest working distance for easy integration and personnel safety

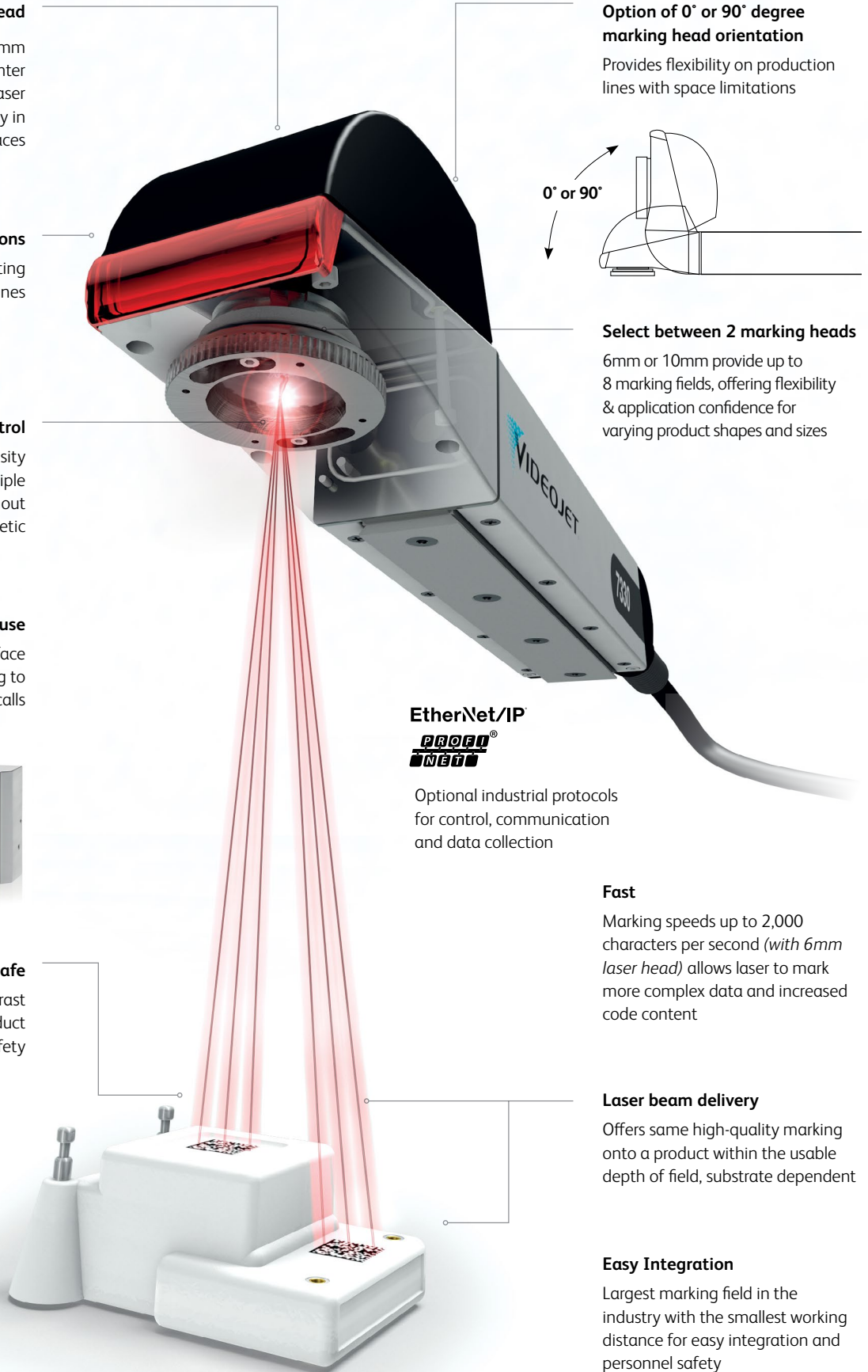

## Laser beam delivery

Fiber lasers provide excellent beam distribution, and offer high-quality codes onto a product within the usable depth of field, substrate dependent.

The Videojet 7230 and 7330 fiber lasers help to ensure optimal performance at high speeds with an enhanced depth of field laser beam, offering manufacturers the benefit of coding products without physically moving the marking head, or working within the depth of field without needing to auto-focus the laser.

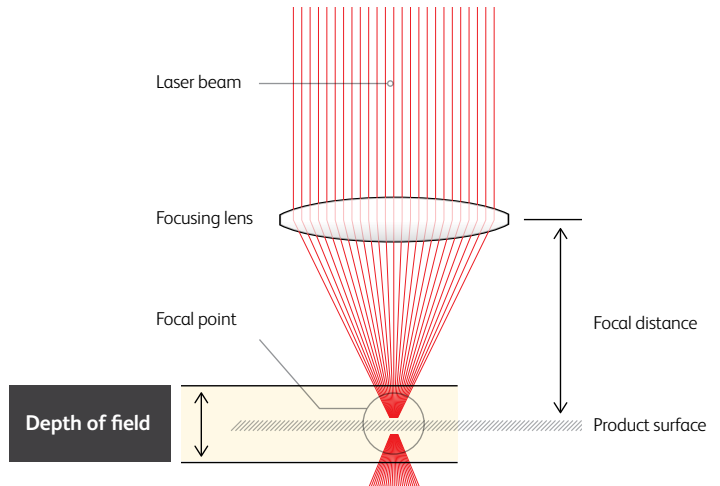

## Light, compact, agile and adaptable

Benefit from greater versatility and easier integration into packaging lines and equipment with a compact, lightweight laser solution. These enhanced fiber laser offerings have a combined laser head and laser controller weight of less than 25kg and is dramatically lighter than other fiber laser providers in the market today.

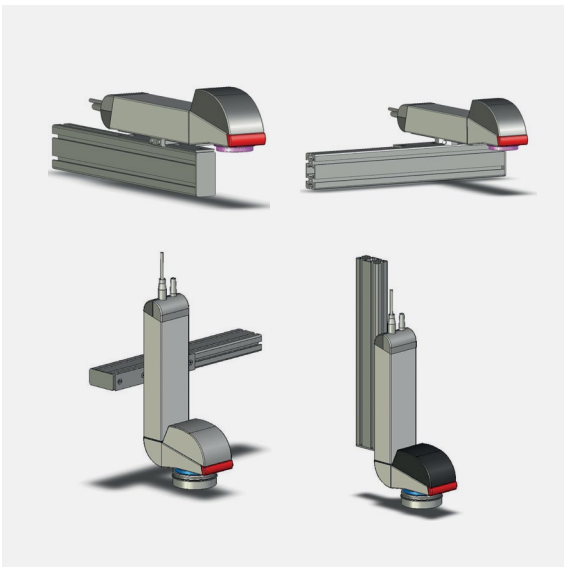

## Available with optional EtherNet / IP™ and PROFINET®

Easily adapt your laser marking solution to fit your line with optional EtherNet / IP™ and PROFINET industrial protocols, allowing for greater control, communication and data collection.



Ethernet/IP is a trademark of ODVA. PROFINET is a registered trademark of Profibus & Profinet International (PI).

## Optimized for a wide range of marking applications:

- Choose from the industry's smallest marking head to provide optimal performance in your specific application – the 6mm head is optimized for high-speed production, while a 10mm head is ideal for parts-marking with fine detail
- Straight or 90-degree head orientation provides flexibility on production lines with space limitations
- Smallest working distances combined with the widest marking fields in the industry offer integration into packaging machinery or lines with physical constraints



### 6mm is best for:

Fast moving products, coding at high speeds and large code content



### 10mm is best for:

Precise coding with small spot size, ideal for parts marking manufacturers

## Smallest laser head, combined with the widest marking fields in the market\*

\*Against other fiber laser providers

6 mm marking head (all values in mm)				
Focal length (f)	50	100	165	258
Working distance	56 ±2	106 ±3	170 ±4	263 ±5
Max. A	19	70	115	180
Max. B	26	70	115	180
Max. a	13	50	83	130
Max. b	18	65	108	169

10 mm marking head (all values in mm)				
Focal length (f)	100	163	254	420
Working distance	127 ±2	229 ±2	345 ±4	549 ±7
Max. A	75	142	215	361
Max. B	118	193	301	498
Max. a	53	107	152	255
Max. b	102	162	278	455

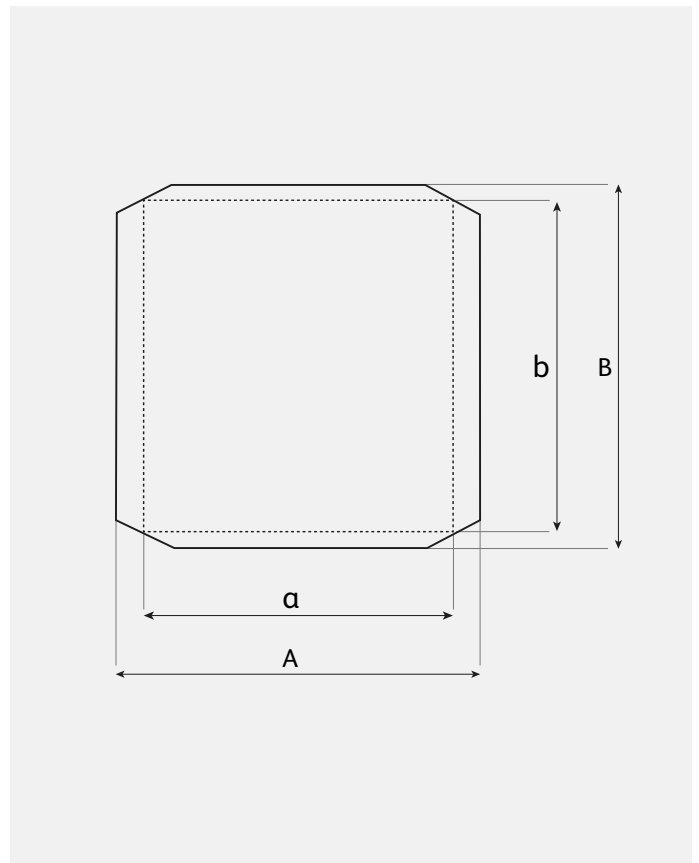

# Laser control at a new level

Available with virtually any Videojet laser marking system, our range of laser controllers allows for simple operation and message creation, with a familiar look and feel touchscreen interface to help reduce user errors in production lines.

## Videojet Touch Control Software (TCS+)

**Videojet TCS+** is designed to offer you flexible integration, simple operation and remote laser control through either the Videojet TU440 laser controller, or from virtually any browser-based device.

The TU440 laser controller features a 10.1" color touchscreen, and the TCS+ software offers operators the benefit of automated message and code entry, helping to reduce the risk of rework and recalls.

An event-logging feature helps to track system changes, and the enhanced user access control minimizes user-induced coding errors and downtime.

Multiple laser marking systems can be controlled from TCS+ software running on a web browser.

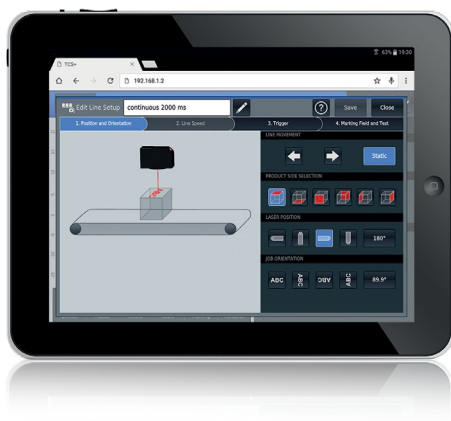

LAN or WiFi network







“Now I have the freedom to choose the laser user interface that works best for me and my production set-up”

## Videojet CLARiTY™ Laser Controller

Also available with the 7230 and 7330 Fiber Lasers, the **Videojet CLARiTY™ Laser Controller** features a color interface with built-in Code Assurance software to help minimize coding and marking errors. Research shows that of the facilities who experience coding errors, 50% – 70% of cases are likely to be operator errors.

Bad codes can mean waste, rework, regulatory fines and potential damage to your brands.

In addition, on-screen diagnostics track the causes of downtime and help with troubleshooting to get your line back up and running quickly. Simple operation, designed with tools to drive continuous, sustainable improvements, helps enhance your uptime and productivity.

The CLARiTY interface is also used in other Videojet coding and marking technologies, allowing operators in mixed production environments to seamlessly switch between lines.

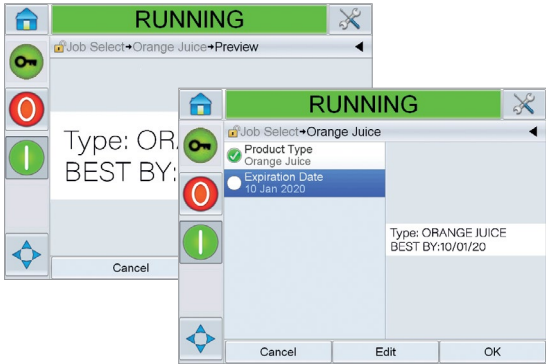

# Parts-Marking Manufacturers

Fiber laser marking is an ideal solution for many parts-marking manufacturers where complex, permanent codes are required to be marked directly onto various part shapes, sizes and substrates, especially at high speeds. The improved print speeds of up to 2,000 characters per second using the 6mm laser marking head enable better code quality as the laser head has more time to engage and mark the product.

Specifically engineered for marking on high-density plastics, aluminium, and stainless steel, the Videojet 7230 and 7330 range of fiber lasers provides you with permanent, traceable, and readable codes. This is particularly important for the automotive and aerospace parts manufacturers who require DataMatrix codes and / or human-readable information that needs to be delivered in a durable format to last throughout the lifetime of the product.

Easy integration into your production setting and processes is important, and the Videojet 7230 and 7330 fiber lasers offer greater versatility in tight spaces, especially when the lasers need to be integrated into complex machinery.

Videojet research shows that 62% of manufacturers surveyed said simplicity and ease of use is the top priority for coding and marking equipment in their facility.\* These enhanced fiber lasers feature an easy-to-operate, color user interface that is familiar and intuitive to the operator without the need for additional training. Videojet fiber laser technology is virtually maintenance-free and contains very few wear parts, resulting in greater uptime and providing consistent codes on your parts-marking production line.

\* Source: Survey of 250 users, published Jan. 31, 2017. VID DFC-9F9-2C2

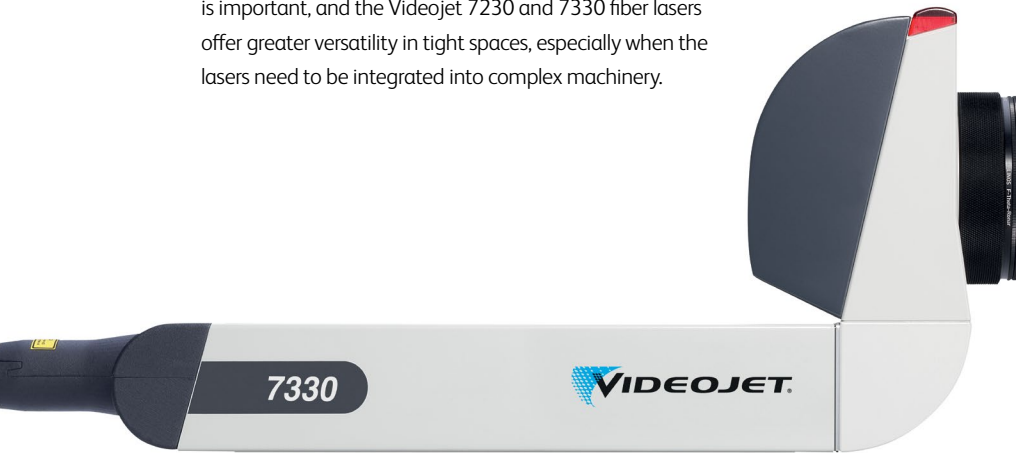

**60%**  
smaller laser head  
versus leading laser  
manufacturers

## Freedom to:

Achieve precise laser beam delivery

Mark high-quality codes at high speeds

Code onto different part shapes and sizes

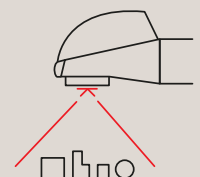
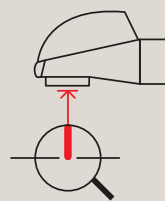
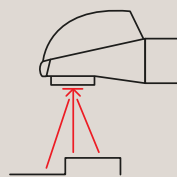

## How:

With high-quality marking onto a product within the depth of field, substrate dependent

With ultra-precise beam control for finest detail reproduction

With the widest selection of marking fields



Automotive plastic parts



Electronic plastic parts



Metal parts



Aluminium parts



Plastic parts



**Integrate into tight spaces offering greater versatility**

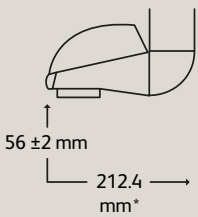

With a smaller, lighter laser system footprint with shortest working distance space

\*6mm laser marking head

**Minimize coding errors**



With an easy-to-use, familiar look and feel user interface

**Control, communicate and collect data**

**EtherNet/IP**



With optional EtherNet / IP™ and PROFINET industrial protocols

# Food, Beverage and Consumer Packaged Good (CPG) Manufacturers

Videojet understands the unique challenges that food, beverage and CPG manufacturers face on their production lines. Product integrity, code quality and high speeds, across differing packaging types, are just some of these challenges.

To meet these needs, the Videojet 7230 and 7330 fiber lasers have been designed to ensure laser marks are clearly and accurately positioned, offering code precision that doesn't adversely impact product aesthetics on demanding food, beverage and CPG lines.

The larger marking fields of the 7230 & 7330 fiber lasers, versus other fiber laser manufacturers, also provide an excellent opportunity for improved code quality, offering clean and crisp codes that complement the product's packaging.

With Videojet 7230 and 7330 fiber lasers, food, beverage and CPG manufacturers can run their lines at top speeds without worrying about code appearance or coding errors.



## Freedom to:

Mark crisp, beautiful codes at high-speeds for the most demanding customers and brands

Code multiple shapes and substrates without damaging product aesthetics

Integrate into tight spaces offering greater versatility

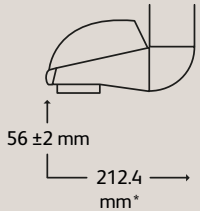
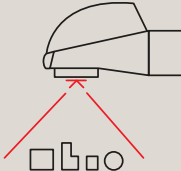
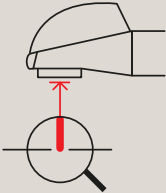

## How:

With ultra-precise beam control for finest detail reproduction

With the widest selection of marking fields

With a smaller, lighter laser system footprint with shortest working distance space

\*6mm laser marking head

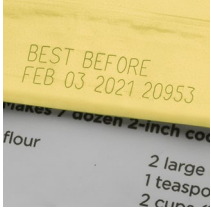

Foils/films



Cups



Food/beverage cans



Beverage caps



Metal containers



Minimize coding errors



With an easy-to-use, familiar look and feel user interface

Control, communicate and collect data

**EtherNet/IP<sup>®</sup>**  
**PROFINET<sup>®</sup>**

With optional EtherNet / IP™ and PROFINET industrial protocols

# Pharmaceutical and Cosmetics Manufacturers

Pharmaceutical and cosmetics manufacturers work with multiple, high-density packaging substrates across a wide range of materials including metals, plastics and foils. Packaging types and materials can vary from product to product, and you need the flexibility to keep up with regulations in your market, while increasing efficiency and protecting your brand.

The Videojet 7230 and 7330 fiber laser marking systems can mark permanent codes at high production speeds without compromising on print quality, uptime performance, code length and content.

The 7230 and 7330 lasers are compact, flexible and easy solutions that provide the best combination of marking speed and permanent codes, to help ensure product security. They offer a lighter, more compact and more adaptable laser solution that provides high-quality, complex codes at high

The enhanced fiber lasers also feature an easy-to-operate, color user interface that is familiar and intuitive to the operator without the need for additional training.



## Freedom to:

Process more complex data and mark increased code content, quickly

Integrate into tight spaces offering greater versatility

Minimize coding errors

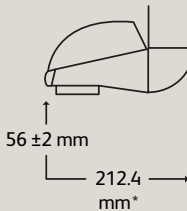

## How:

With competitive marking speeds of 60%-100% faster than previous Videojet models.

With a smaller, lighter laser system footprint with shortest working distance space

With an easy-to-use, familiar look and feel user interface

\*6mm laser marking head



Blister packs



Vial caps

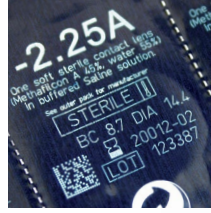

Foil packaging



Tubes



Paper cartons



Increase product safety



With a permanent laser coding solution that helps to increase product security

Control, communicate and collect data



With optional EtherNet / IP™ and PROFINET industrial protocols

# Peace of mind comes as standard

Videojet Technologies is a world-leader in the product identification market, providing in-line printing, coding, and marking products, application specific fluids, and product LifeCycle Advantage™.

Our goal is to partner with our customers in the consumer packaged goods, pharmaceutical, and industrial goods industries to improve their productivity, to protect and grow their brands, and to stay ahead of industry trends and regulations. With our customer application experts and technology leadership in Continuous Inkjet (CIJ), Thermal Inkjet (TIJ), Laser Marking, Thermal Transfer Overprinting (TTO), case coding and labeling, and wide array printing, Videojet has more than 400,000 printers installed worldwide.

Our customers rely on Videojet products to print on over ten billion products daily. Customer sales, application, service and training support is provided by direct operations with over 4,000 team members in 26 countries worldwide. In addition, Videojet's distribution network includes more than 400 distributors and OEMs, serving 135 countries.

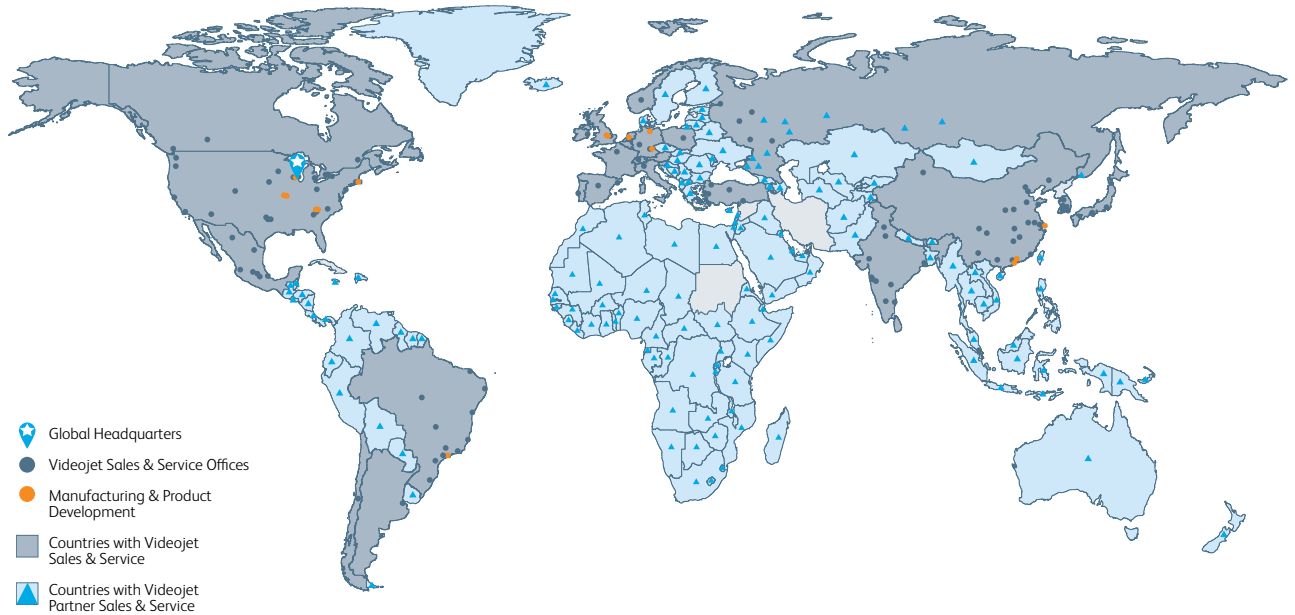

**New printer quote 866-871-3226**

Order supplies [shop.videojet.com](http://shop.videojet.com)  
Call **800-843-3610**  
Email [info@videojet.com](mailto:info@videojet.com)  
visit [www.videojet.com](http://www.videojet.com)

Videojet Technologies Inc.  
1500 Mittel Blvd. Wood Dale IL 60191 / USA

©2021 Videojet Technologies Inc. All rights reserved.  
Videojet Technologies Inc.'s policy is one of continued product improvement. We reserve the right to alter design and/or specifications without notice.

Part No. SL000675  
br-7230-7330-us-0721  
Printed in U.S.A.

